

### TOP VIEW

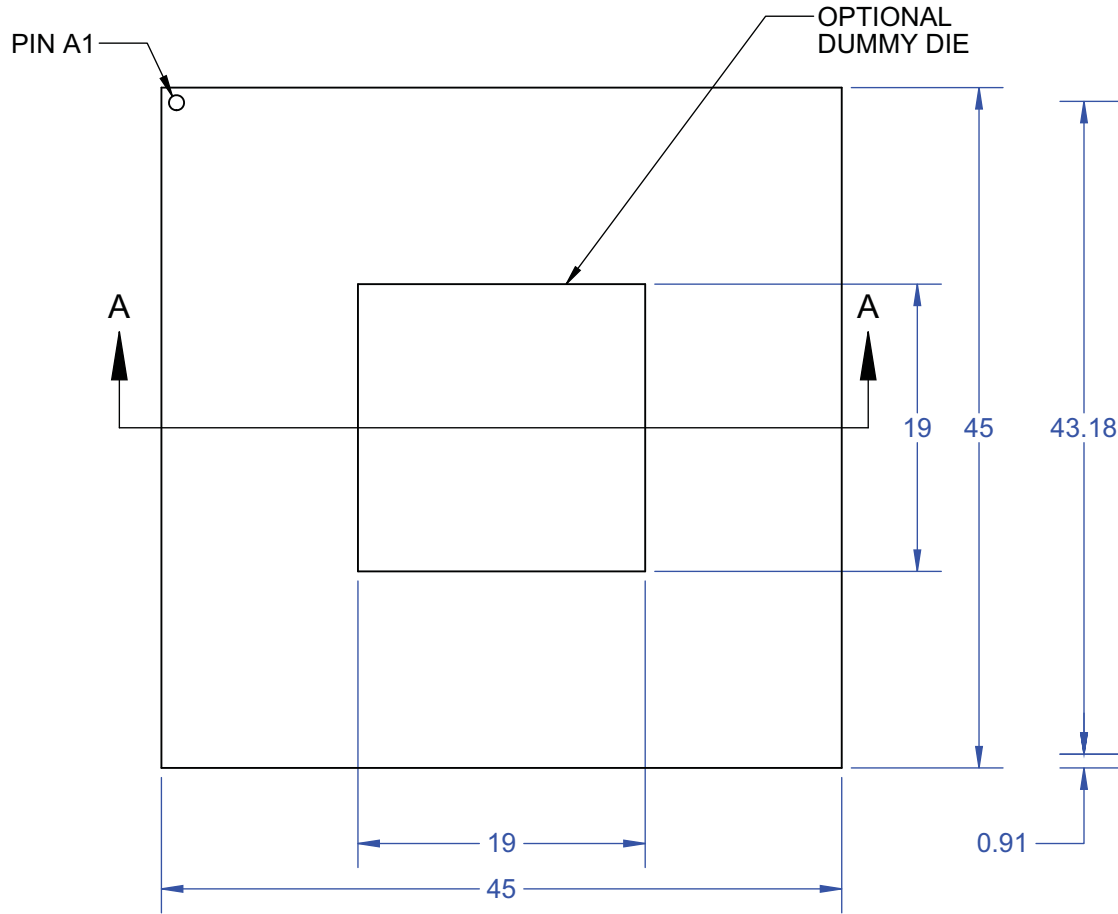

### BALL VIEW

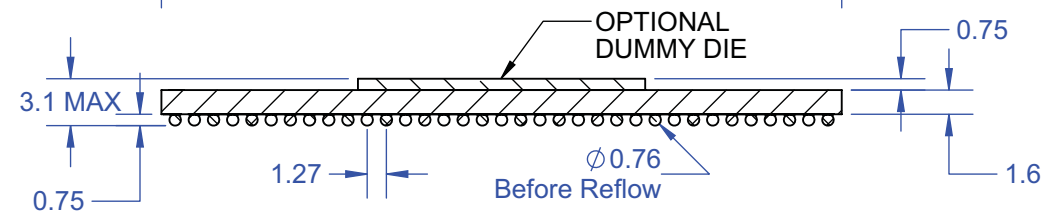
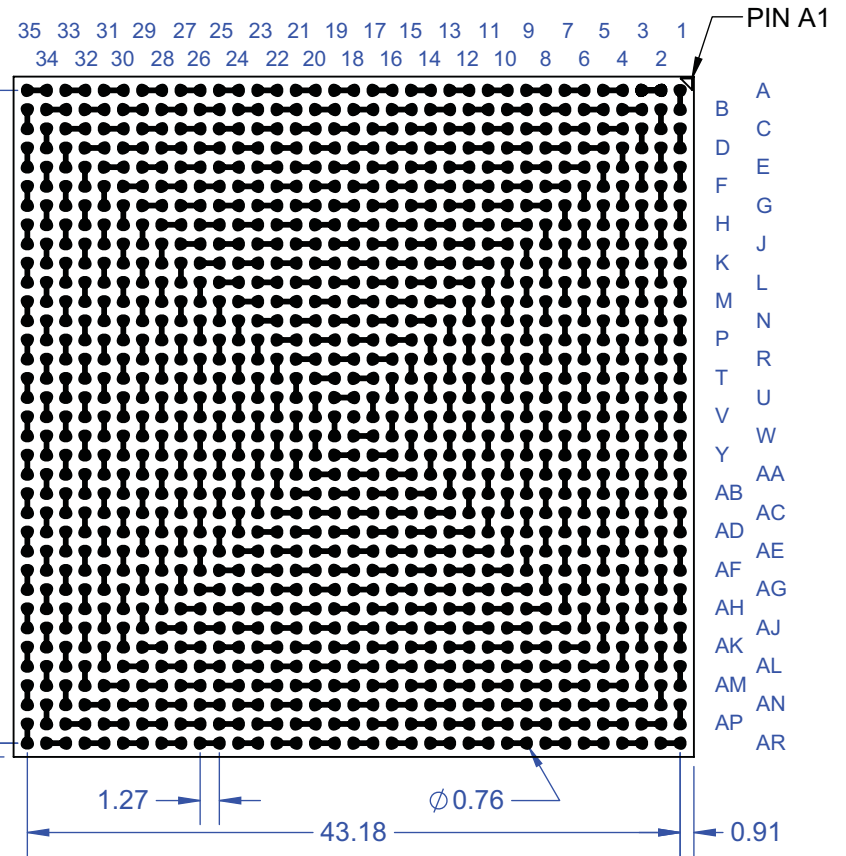

SECTION A-A

Notes: (Unless Otherwise Specified).

- 1) ALL DIMENSIONS ARE IN MM.
- 2) SOLDER BALL ALLOY: SEE PART NUMBER TABLE.
- 3) BALL DIAMETER (BEFORE REFLOW): 0.762mm (30 MIL).
- 4) SOLDER MASK DEFINED PAD OPENING: 0.610mm (24 MIL).
- 5) PAD Cu DIAMETER: 0.838mm (33 MIL).
- 6) SUBSTRATE MATERIAL: FR4 (ALTERNATE BT or Polyimide).
- 7) DUMMY DIE IS OPTIONAL.
- 8) DAISY CHAIN PATTERN (SEE PAGE 2).
- 9) MSL-3 RECOMMENDED BAKING 24 HOURS @ 125°C TO REMOVE MOISTURE PRIOR SOLDERING TO PC BOARD.

PART NUMBER TABLE

PART NUMBER	BALL ALLOY	Pb-FREE	RoHS	Si DIE
LBGA1225T1.27C-DC359	Sn96.5/Ag3.0/Cu0.5	YES	YES	NO
LBGA1225T1.27C-DC359D	Sn96.5/Ag3.0/Cu0.5	YES	YES	YES
LBGA1225T1.27-DC359	Sn63/Pb37	NO	NO	NO
LBGA1225T1.27-DC359D	Sn63/Pb37	NO	NO	YES

APPROVALS	DATE				
DRAWN T.Au	10/14/15				
ENG M. Hart	10/14/15	TITLE LBGA1225T1.27-DC359D DAISY CHAIN DUMMY			
MFG		SCALE	SIZE	DRAWING NO.	REV
QA		2:1	A	523591	A
CUST		DO NOT SCALE DRAWING			SHEET 1 OF 7
REVISED					

# BALL VIEW

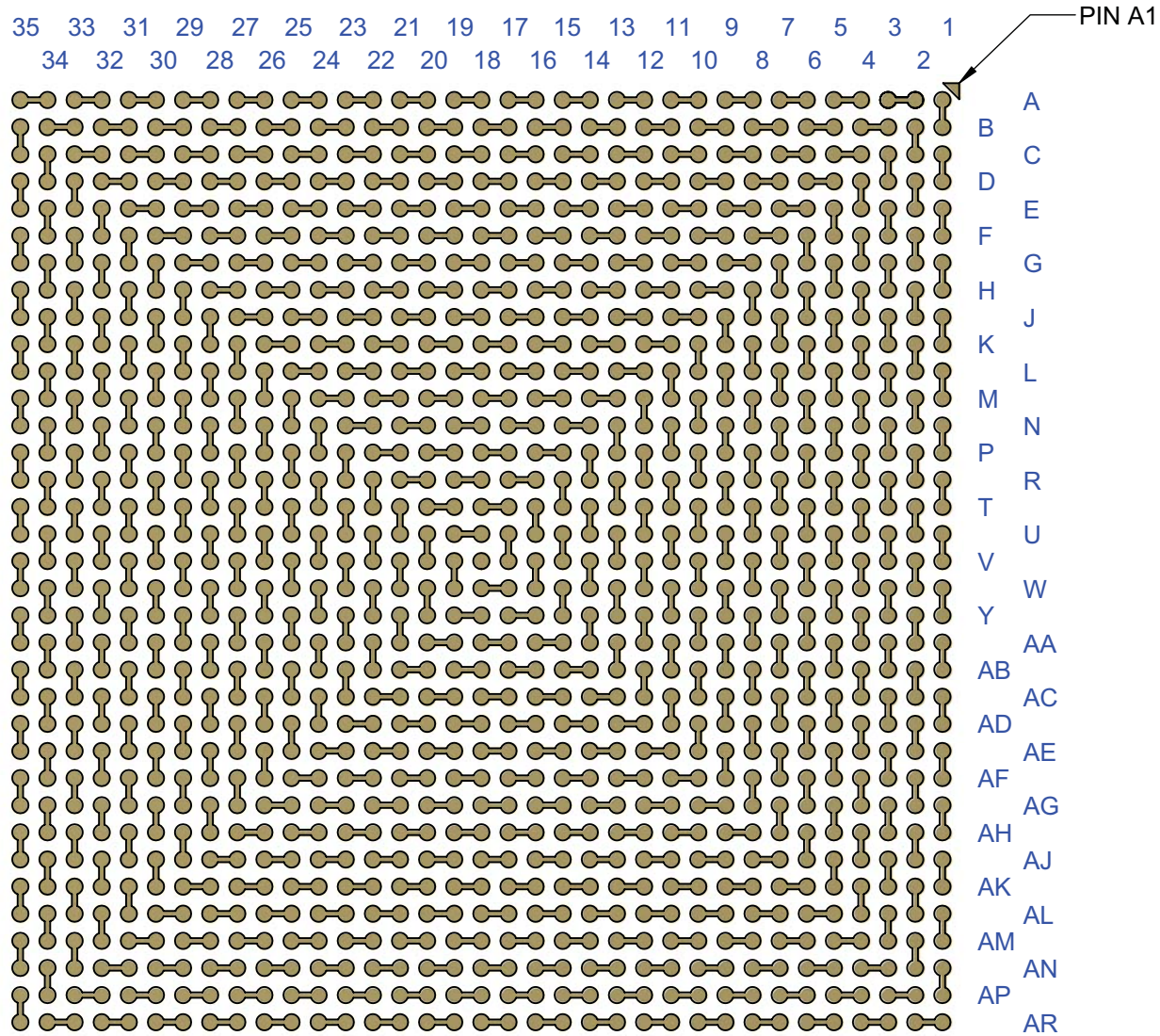

<b>TopLine<sup>®</sup></b>			
TITLE LBG1225T1.27-DC359D DAISY CHAIN DUMMY			
SCALE 3:1	SIZE A	DRAWING NO. 523591	REV A
DO NOT SCALE DRAWING			SHEET 2 OF 7

# BOTTOM SIDE (TOP X-RAY VIEW)

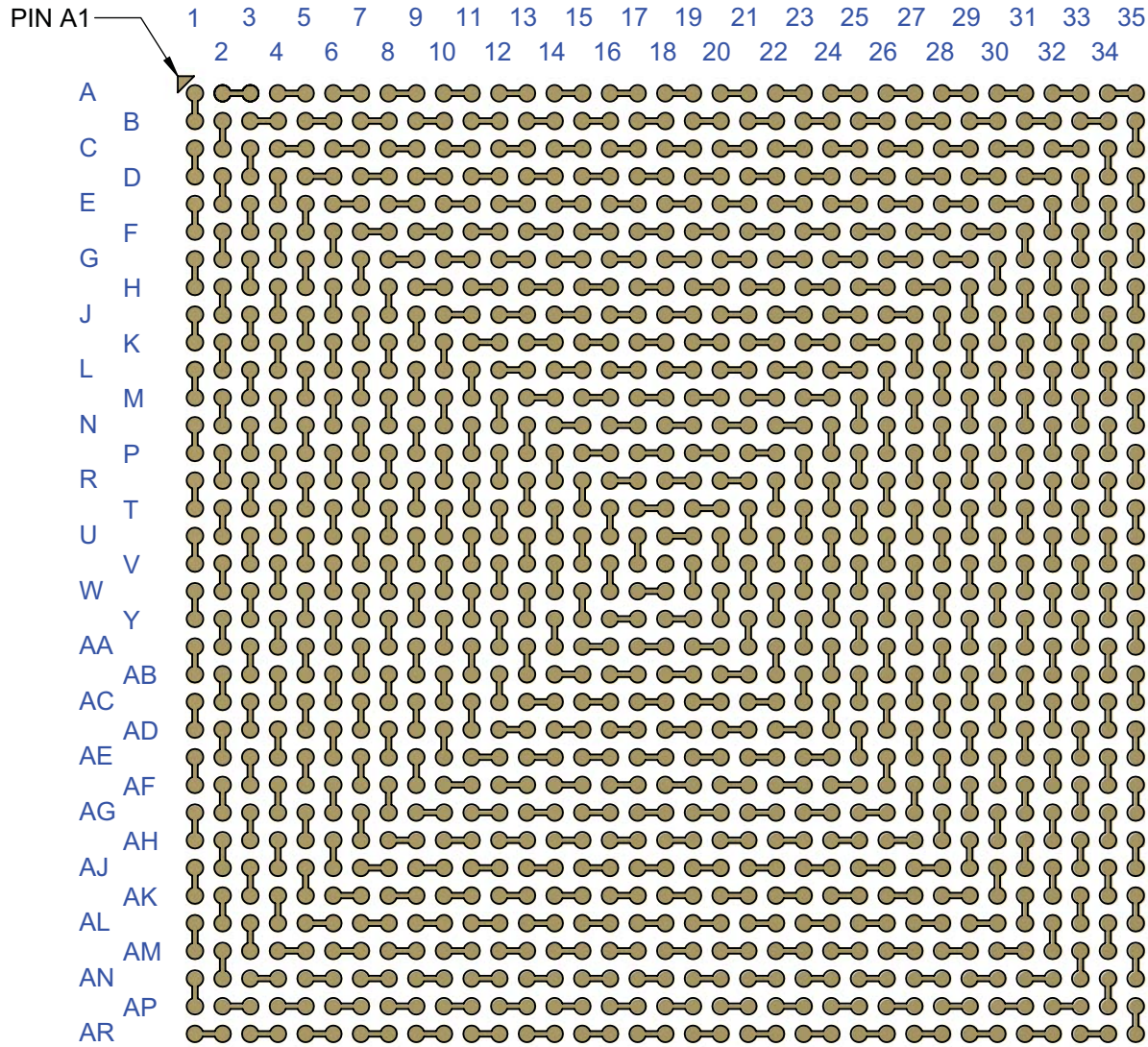

<b>TopLine®</b>			
TITLE <b>LGA1225T1.27-DC359D DAISY CHAIN DUMMY</b>			
SCALE <b>3:1</b>	SIZE <b>A</b>	DRAWING NO. <b>523591</b>	REV <b>A</b>
DO NOT SCALE DRAWING			SHEET 3 OF 7



# TEST VEHICLE BOARD

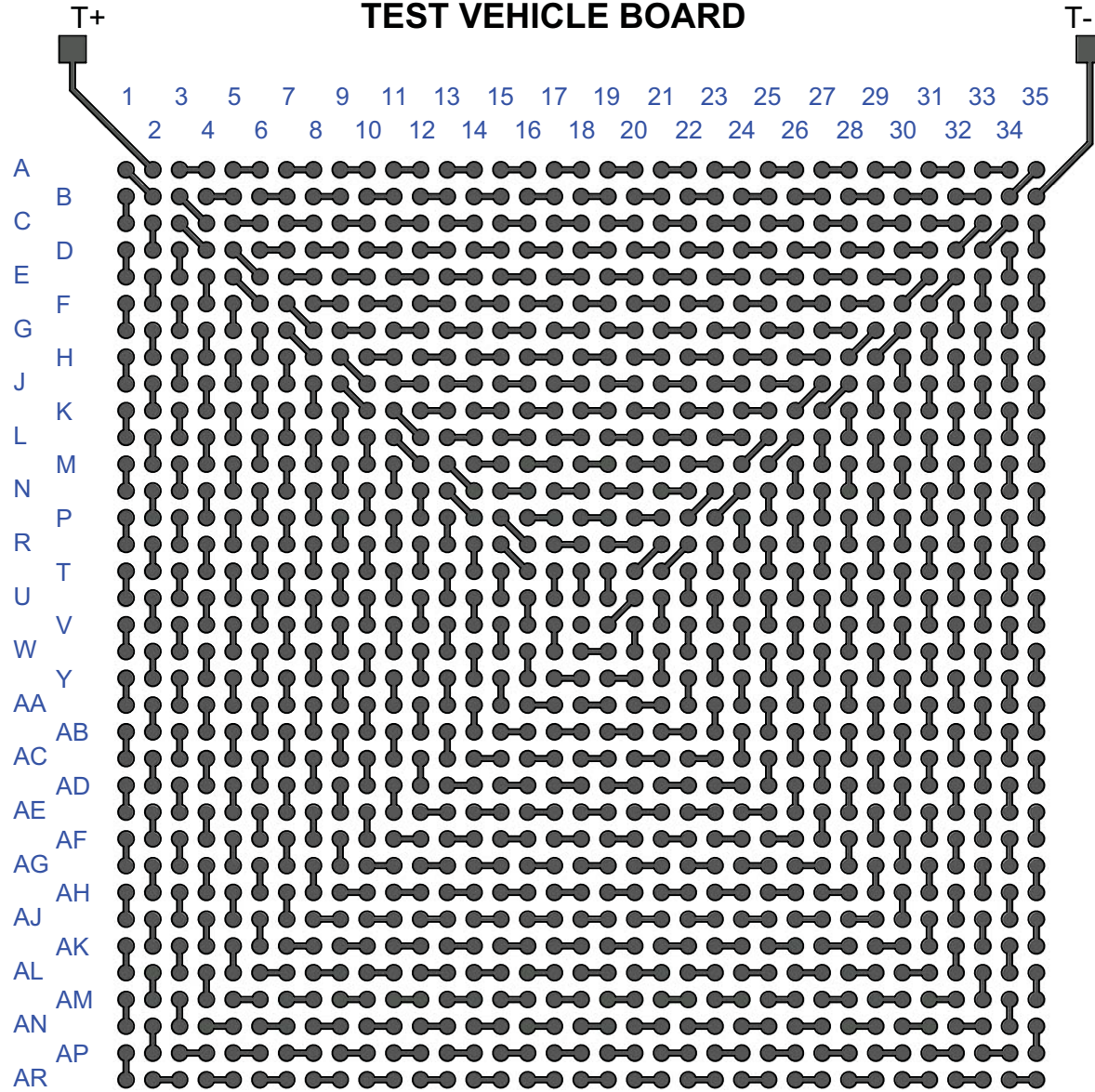

**Notes:**

- 1) PCB BOARD DIMENSIONS ARE PRESENTD ONLY AS A GUIDELINE. DESIGNERS SHOULD USE THEIR OWN EXPERIENCE WHEN DESIGNING PCB.
- 2) PCB Cu BALL PAD DIAMETER 0.838mm [33 MIL].
- 3) PCB DAISY CHAIN TRACING LINE WIDTH 0.254mm [10 MIL].
- 4) SMD (SOLDER MASK DEFINED) PAD OPENING 0.61mm [24 MIL].

<b>TopLine®</b>			
TITLE		LPGA1225T1.27-DC359D DAISY CHAIN DUMMY	
SCALE	SIZE	DRAWING NO.	REV
3:1	A	523591	A
DO NOT SCALE DRAWING			SHEET 4 OF 7

# AFTER MOUNTING

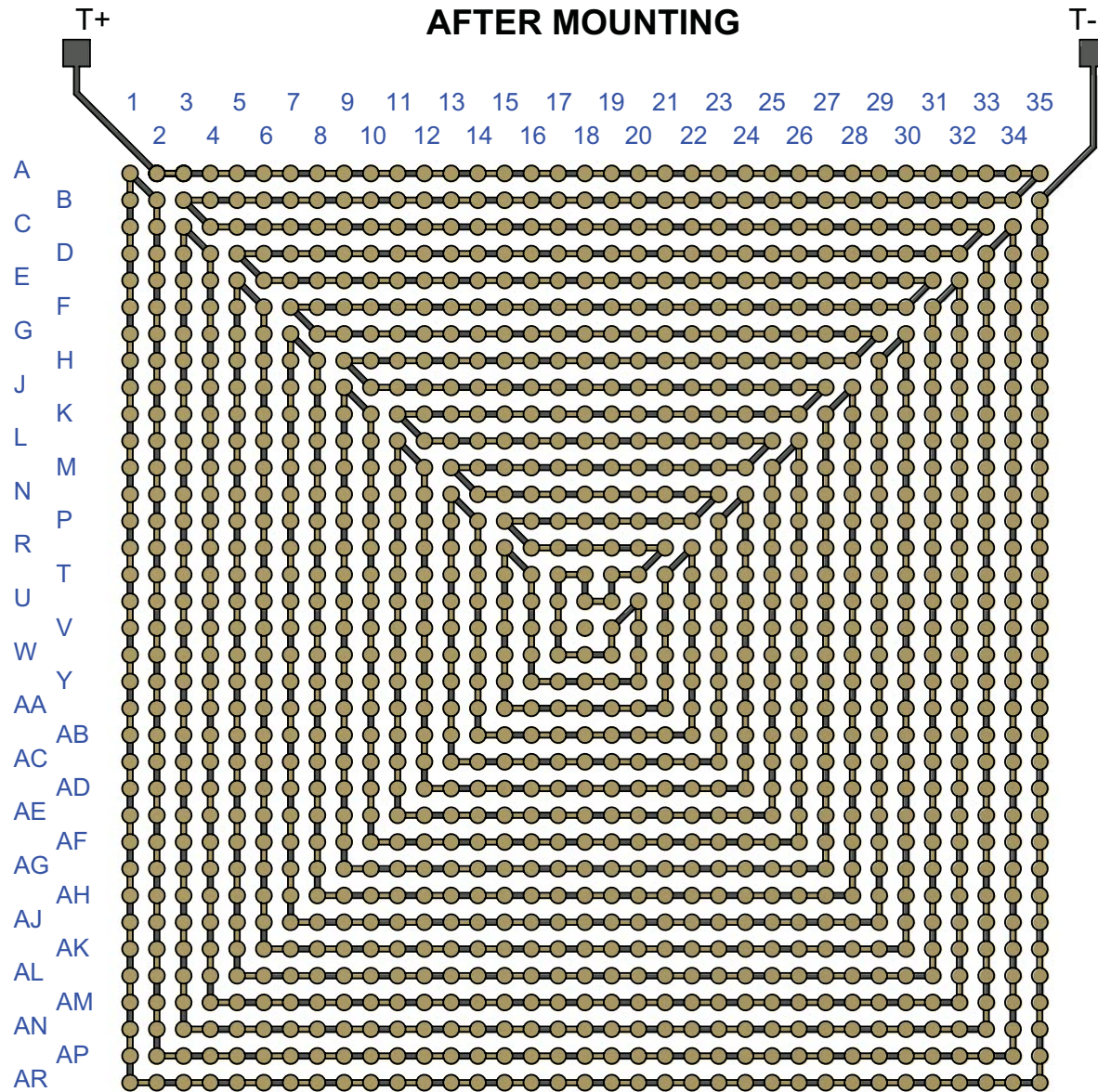

**TopLine**<sup>®</sup>

TITLE LBG1225T1.27-DC359D  
DAISY CHAIN DUMMY

SCALE 3:1	SIZE A	DRAWING NO. 523591	REV A
--------------	-----------	-----------------------	----------

DO NOT SCALE DRAWING

SHEET 5 OF 7



### BALL VIEW

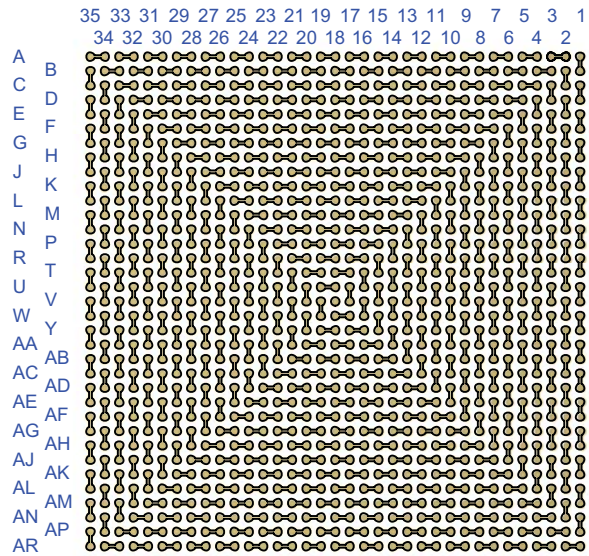

### BOTTOM SIDE (TOP X-RAY VIEW)

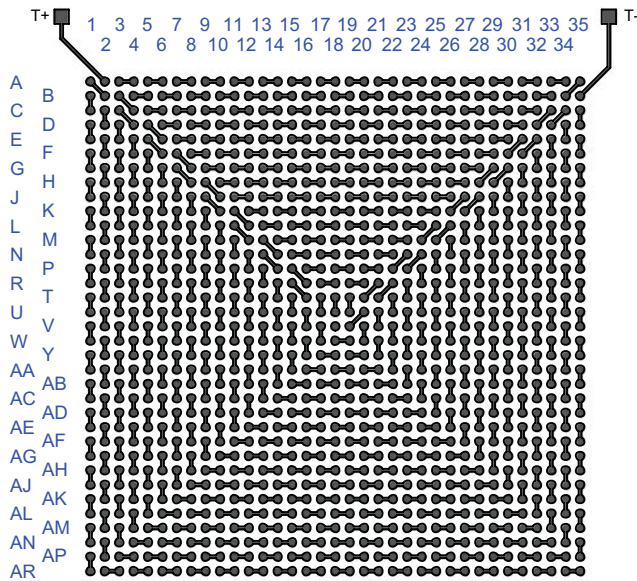
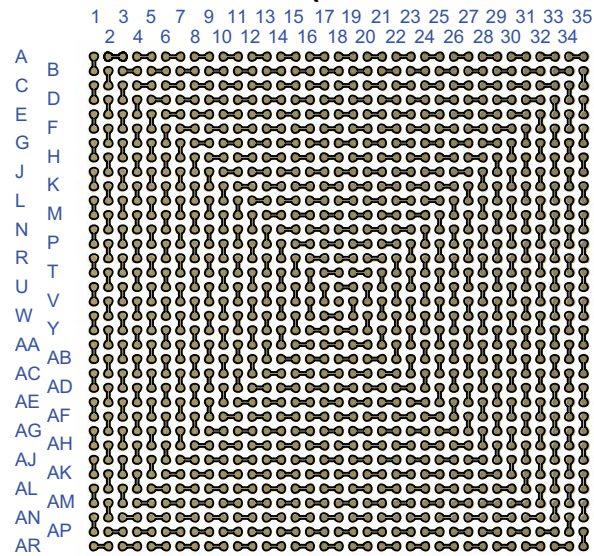

### TEST VEHICLE BOARD

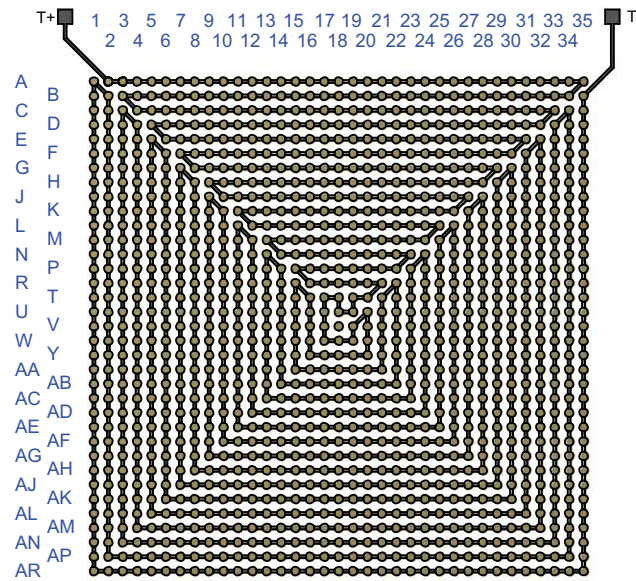

### AFTER MOUNTING

**Notes:**

- 1) PCB BOARD DIMENSIONS ARE PRESENTD ONLY AS A GUIDELINE. DESIGNERS SHOULD USE THEIR OWN EXPERIENCE WHEN DESIGNING PCB.
- 2) PCB Cu BALL PAD DIAMETER 0.838mm [33 MIL].
- 3) PCB DAISY CHAIN TRACING LINE WIDTH 0.254mm [10 MIL].
- 4) SMD (SOLDER MASK DEFINED) PAD OPENING 0.61mm [24 MIL].

<b>TopLine®</b>			
TITLE		LBGA1225T1.27-DC359D DAISY CHAIN DUMMY	
SCALE	SIZE	DRAWING NO.	REV
3:2	A	523591	A
DO NOT SCALE DRAWING			SHEET 6 OF 7

**MODEL**

**WITH DUMMY DIE**

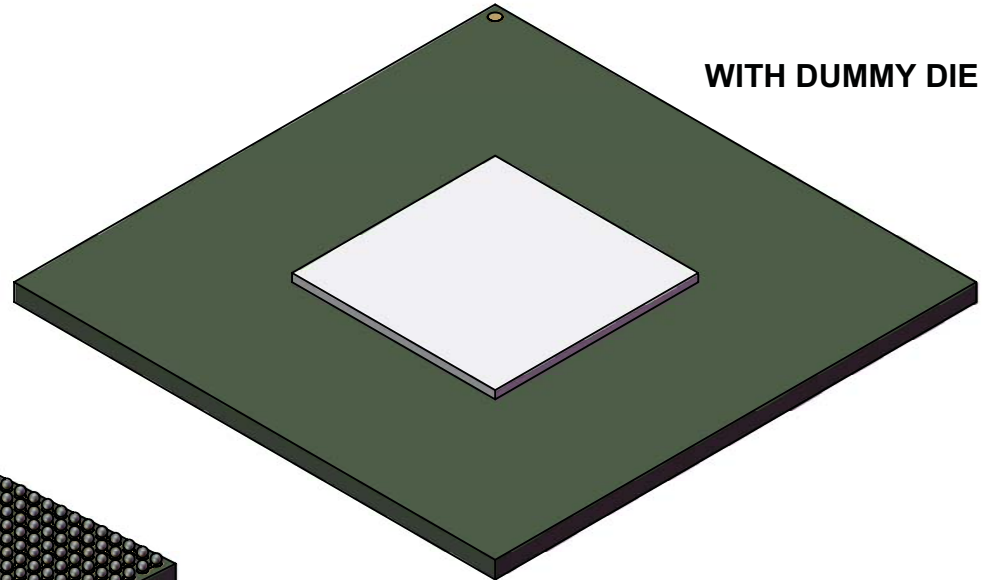

**WITHOUT DIE**

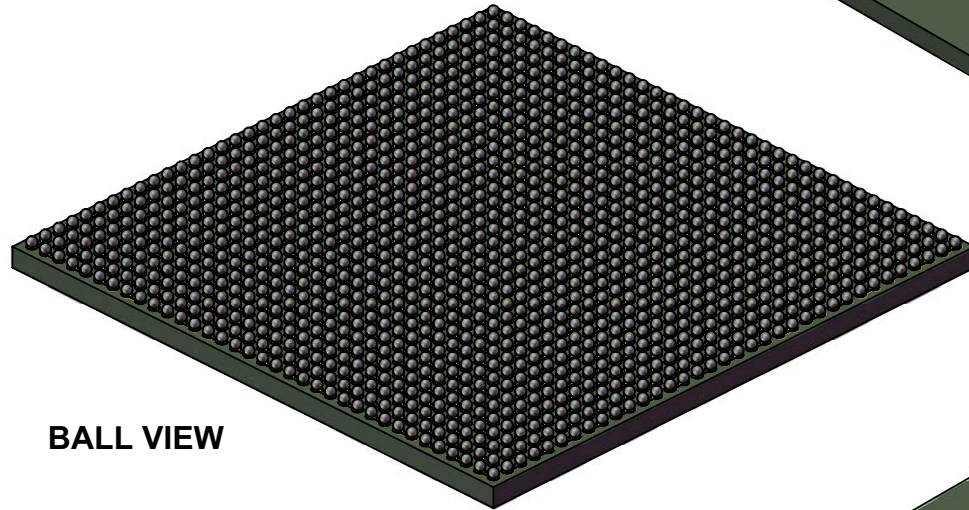
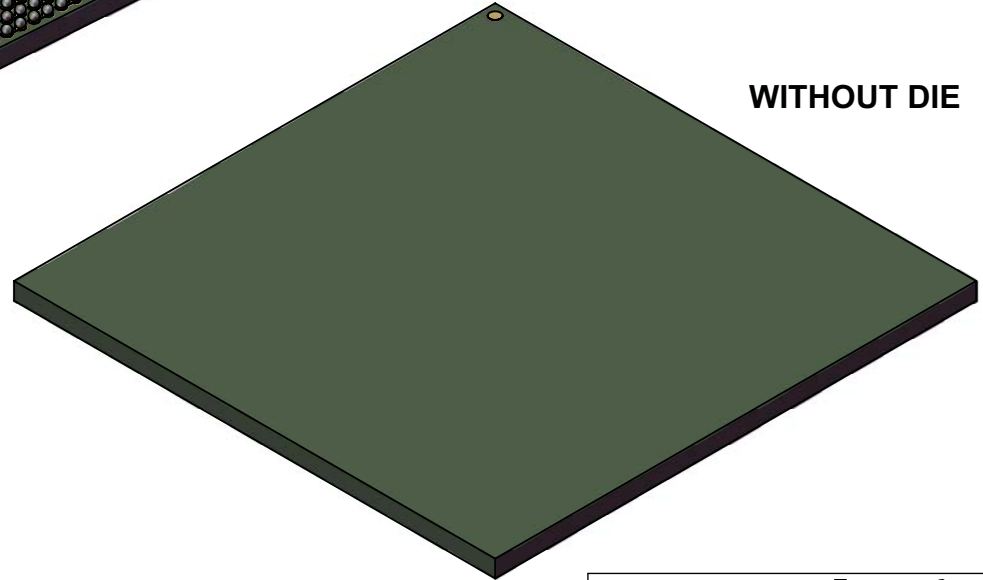

**BALL VIEW**

**TopLine®**

TITLE				LBGA1225T1.27-DC359D DAISY CHAIN DUMMY			
SCALE	SIZE	DRAWING NO.		REV			
2:1	A	523591		A			
DO NOT SCALE DRAWING			SHEET 7 OF 7				